



FOREVER REDWOOD

From the Forest, For the Forest since 1995









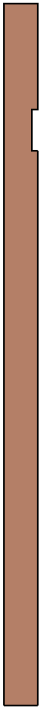
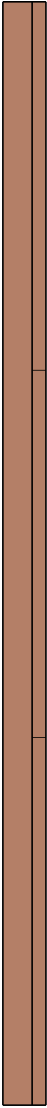

866.332.2403 (TOLL FREE); 7am – 7pm Pacific Time, Monday-Saturday

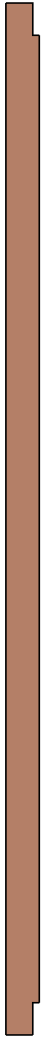
ASSEMBLY INSTRUCTIONS FOR **THE L.A. MODERN PERGOLA**

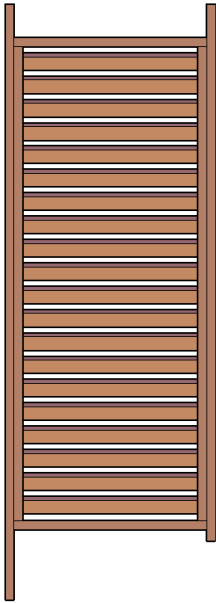





CONTENT OF BOXES

Qty.	Description	Drawing	No.
	Posts		1
	Supports-A		2
	Supports-B		3
	Supports-C		4
	Rafters		5
Will Vary.	Louvered Panels		6
	Boots If ordered		7
	Standard, Gale Wind or Hurricane Anchors Bases. If ordered.	  	8
	Angles		9

Note: Part numbers in the Content of Boxes Table are for reference only. These do not match to the numbers marked on the parts sent.





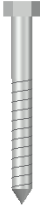
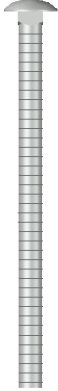
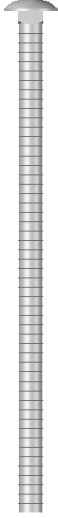
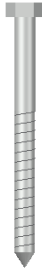

HARDWARE LIST

Description	Drawing		No.
<p>½" X 3 ½" Anchor Bolts or Lag Bolts (To attach the anchor bases to the ground).</p>	 <p style="text-align: center;">Anchor Bolts</p>	 <p style="text-align: center;">Lag Bolts</p>	A
<p>5/16" X 3" Lag Bolts (To attach the anchor bases to the posts. / To attach the angles to the posts and to the Supports-C. / To attach the rafters to the Supports-A).</p>			B
<p>3/8" X 6" Bolts (To attach the Supports-A to the posts).</p>			C
<p>3/8" X 8" Bolts (To attach the Supports-A to the posts).</p>			D
<p>5/16" X 4" Lag Bolts (To attach the Supports-B to the Supports-A).</p>			E

Note: Dimensions of your hardware will vary depending on size.

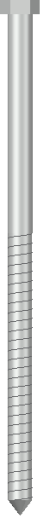
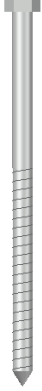

HARDWARE LIST

Description	Drawing	No.
4'' Deck Screws (To attach the Supports-B to the Supports-A. / To attach the rafters to the Supports-A).		F
3/8'' X 8'' Lag bolts (To attach the Supports-C to the posts).		H
5/16'' X 6'' Lag Bolts (To attach the louvered panels to the posts and to the Supports-A).		I
3'' Deck Screws (To attach the boots to the posts).		J
Washers		K
Nuts		L

Note: Dimensions of your hardware will vary depending on size.

DESCRIPTION	No
Posts	1
Supports-A	2
Supports-B	3
Supports-C	4
Rafters	5
Louvered Panels	6
Boots	7
Anchor Bases	8
Angles	9

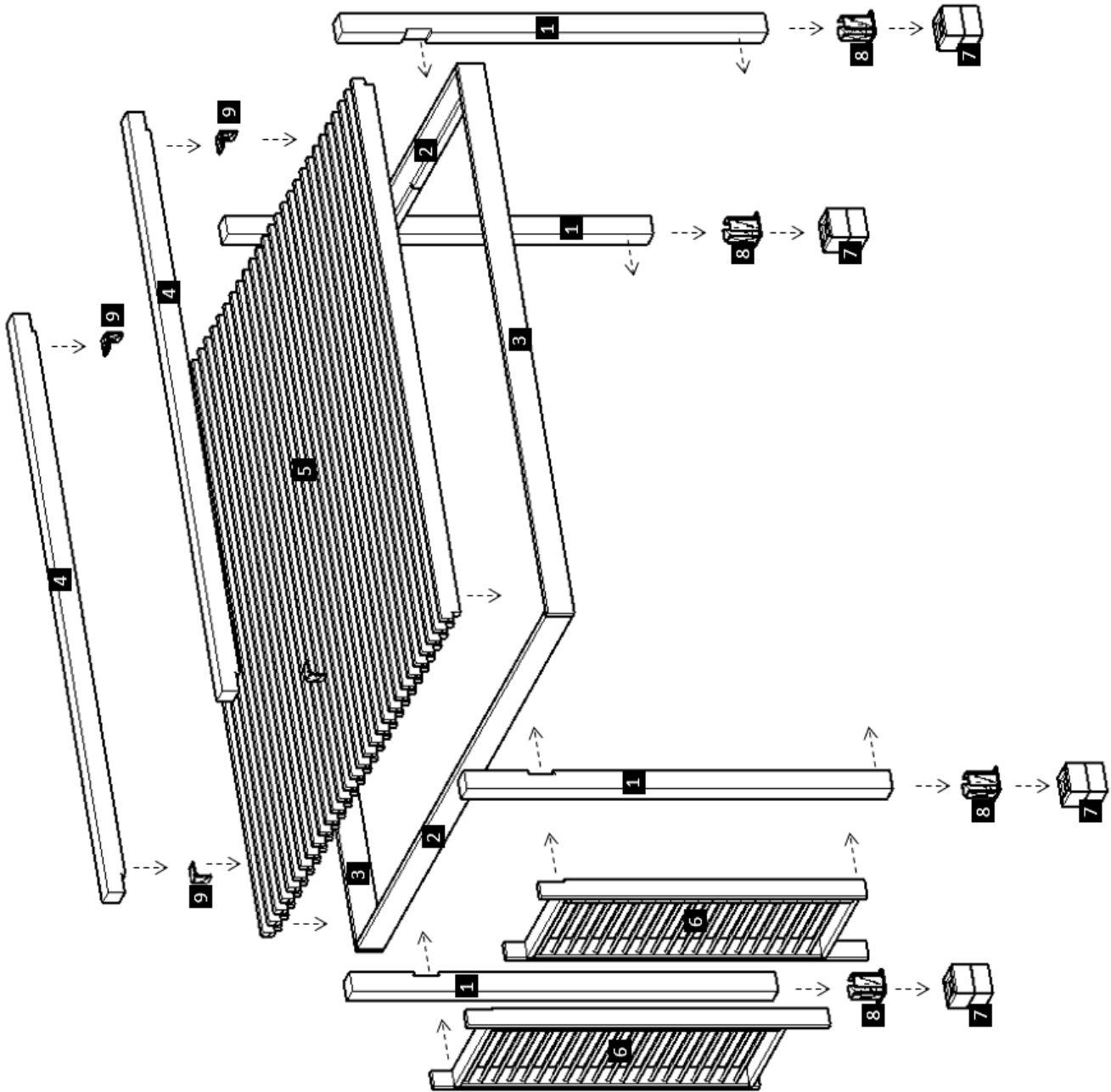

Note: Part numbers in the Drawing are for reference only. These do not match to the numbers marked on the parts sent.

NOTE: In order to know where the post needs to be placed, check the numbers on them. If the post is not marked, then place the single Supports on the ground to locate the markings for each post position and clearly set your bearings. (“Don’t attach yet, only place them on the ground to begin with”).

Step 1: Install the anchor bases (8) with $\frac{1}{2}$ " X $3\frac{1}{2}$ " anchor bolts or lag bolts (A). Please see the “How to anchor your pergola document” for all details. Set your post (1) in the saddle of the anchor bases. Drill a $\phi\frac{1}{4}$ " hole in the post prior to anchoring to facilitate the ratcheting of the hardware. After that, use $\frac{5}{16}$ " X 3" lag bolts (B) to attach each post to its respective anchor base.

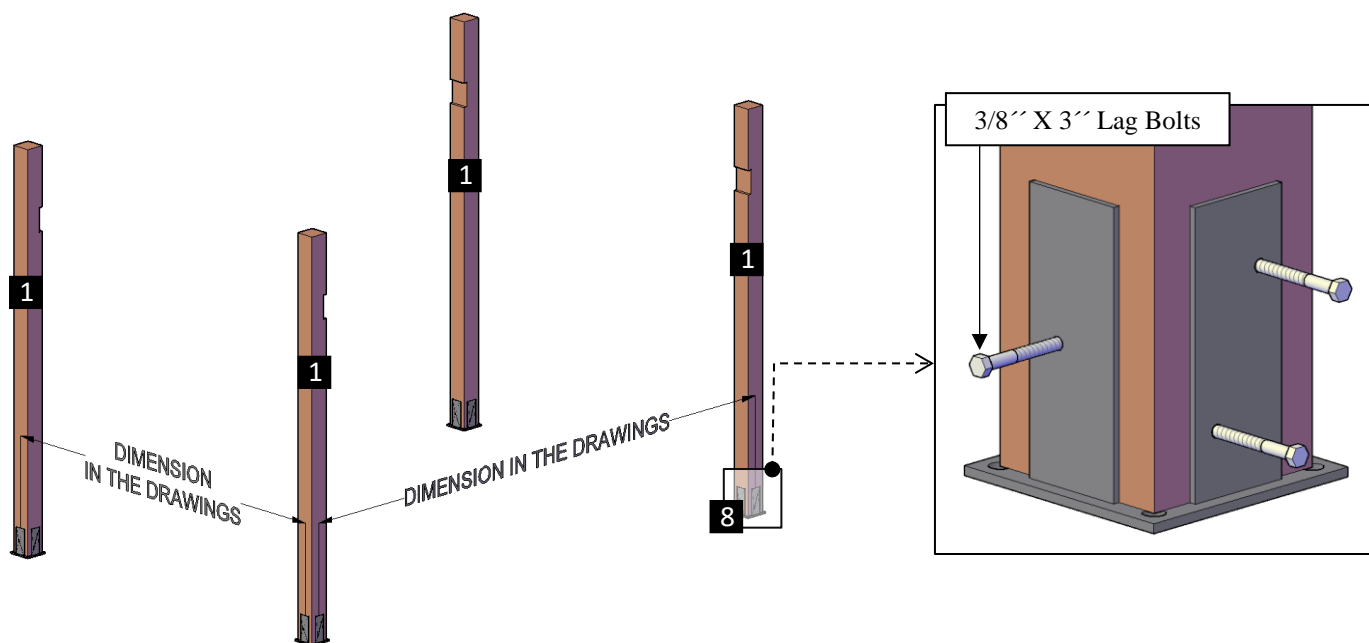

Step 2: Attach the Supports-A (2) to the posts, use $\frac{3}{8}$ " x 6" bolts (C) & $\frac{3}{8}$ " x 8" bolts (D) with washers (K) and nuts (L). Each part has a series of numbers that indicate where to attach the part with the corresponding number.

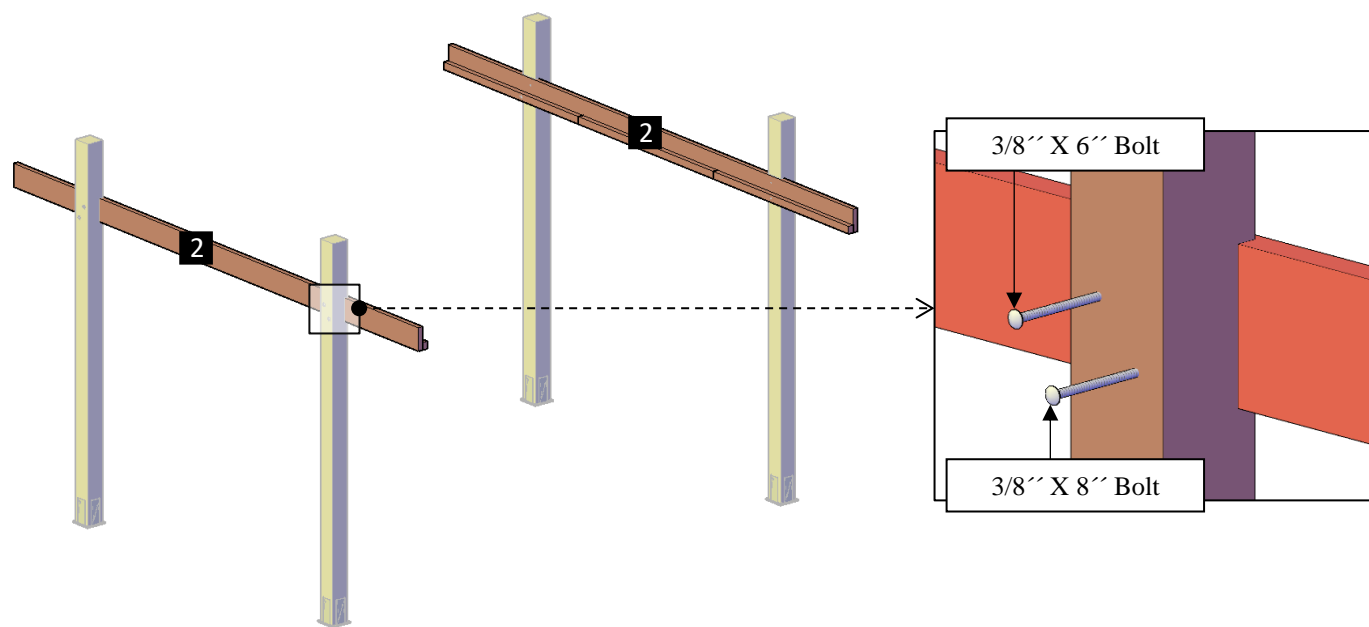

Step 3: Use 5/16" x 4" lag bolts (E) with washers (K) and 4" deck screws (F) to attach the Supports-B (3) to the Supports-A. Each part has a series of numbers that indicate where to attach the part with the corresponding number.

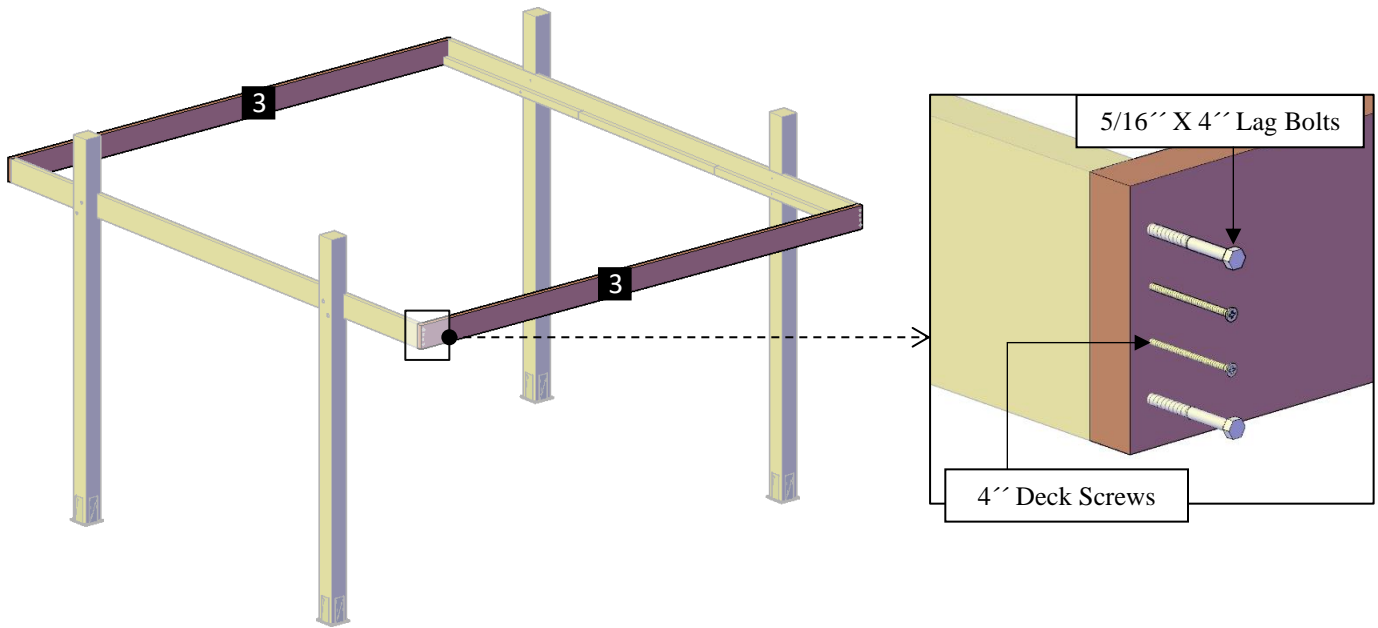

Step 4: Attach the rafters (5) to the Supports-A with 4" deck screws (F). Each part has a series of numbers that indicate where to attach the part with the corresponding number.

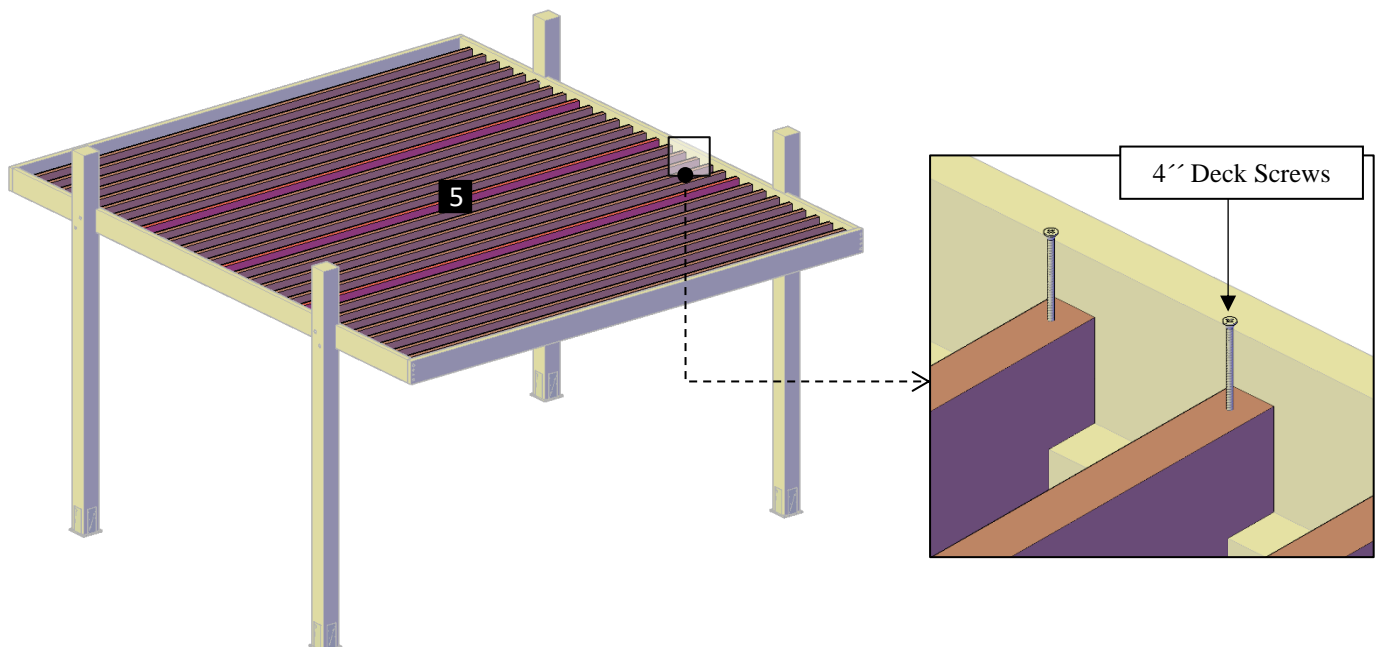

Step 5: Use 5/16" x 3" lag bolts (B) with washers (K) to attach the rafters (4) marked in red to the supports-A. Each part has a series of numbers that indicate where to attach the part with the corresponding number.

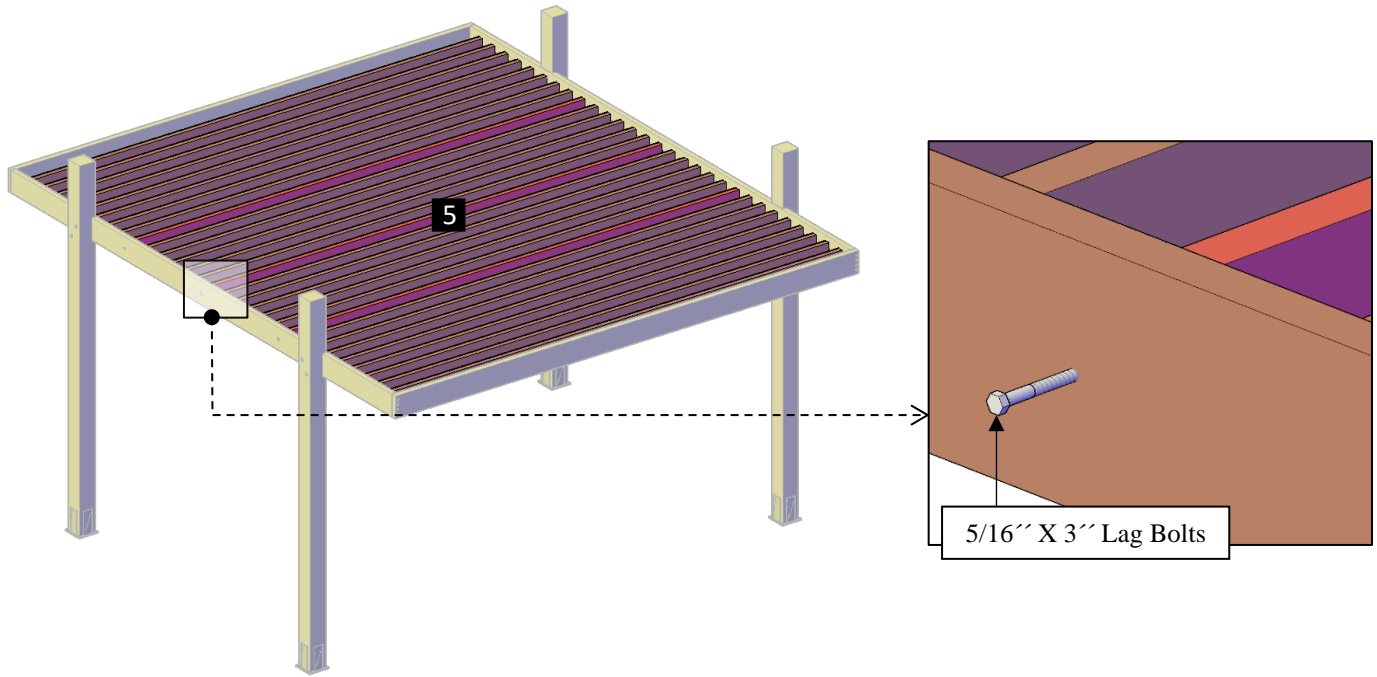

Step 6: Attach the supports-C (4) to the posts, use 3/8" x 8" lag bolts (H) with washers (K). Each part has a series of numbers that indicate where to attach the part with the corresponding number.

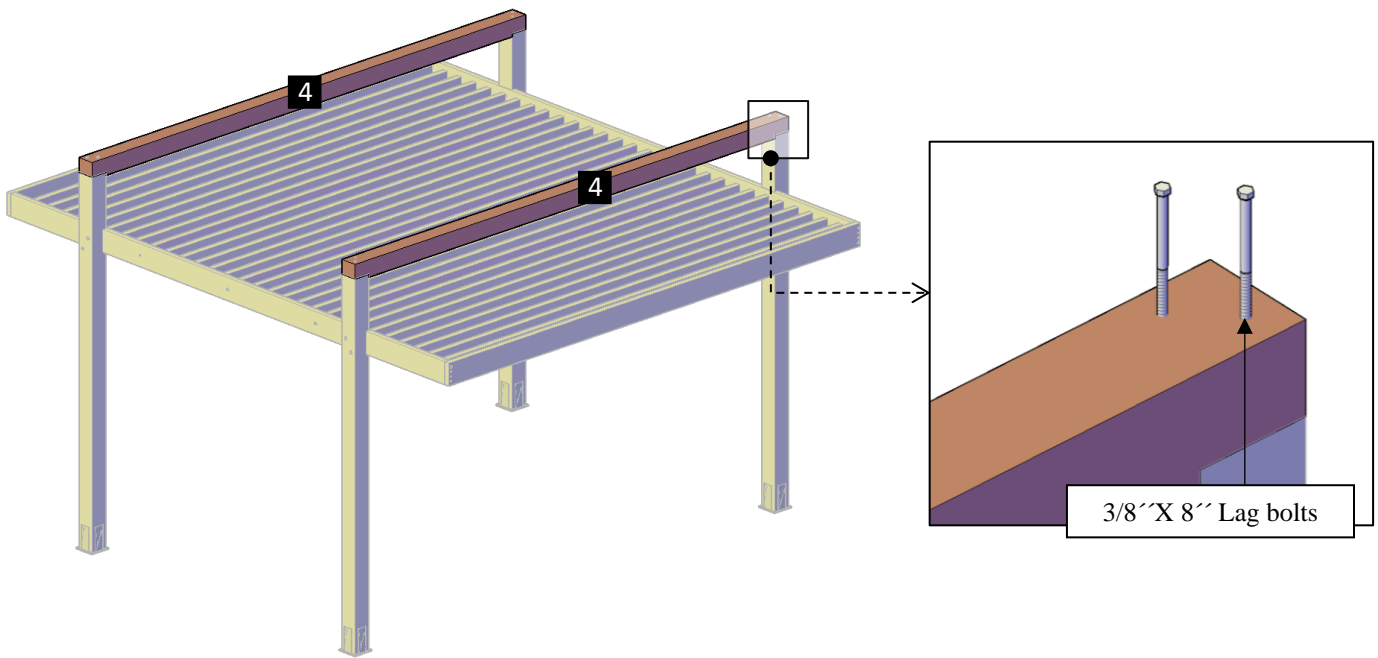

Step 7: Use 5/16" x 3" lag bolts (B) to attach the Angles (9) to the posts and to the supports-C. Each part has a series of numbers that indicate where to attach the part with the corresponding number.

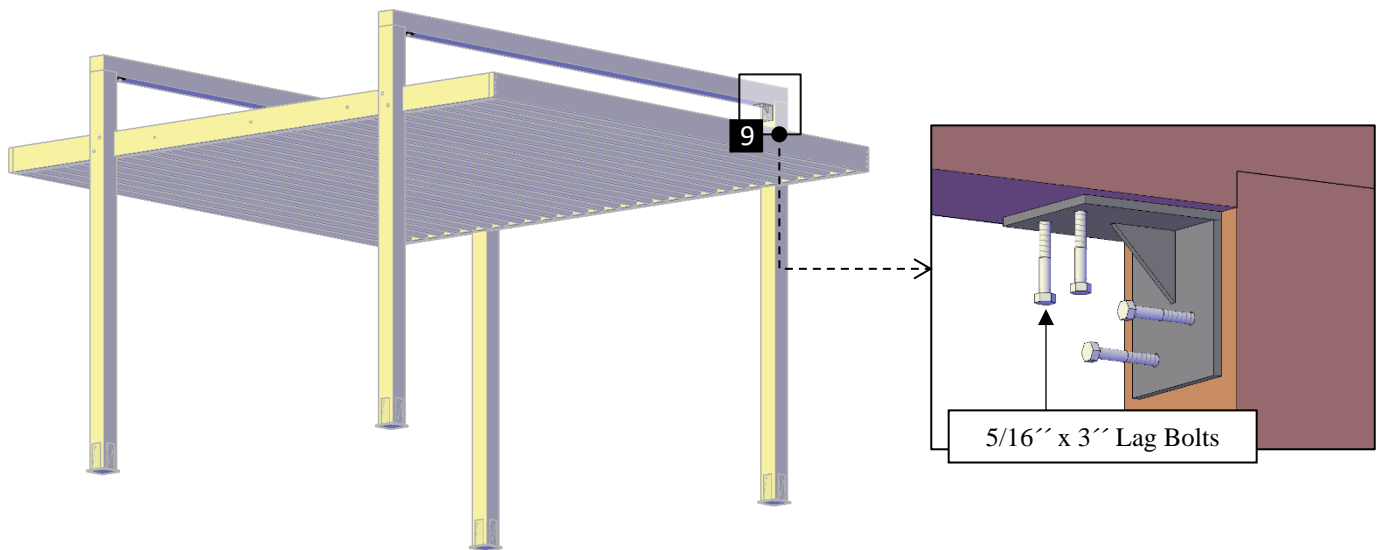

Step 8: Attach the louvered panels (6) to the posts and to the supports-A, use 5/16" x 6" lag bolts (I) with washers (K). Each part has a series of numbers that indicate where to attach the part with the corresponding number.

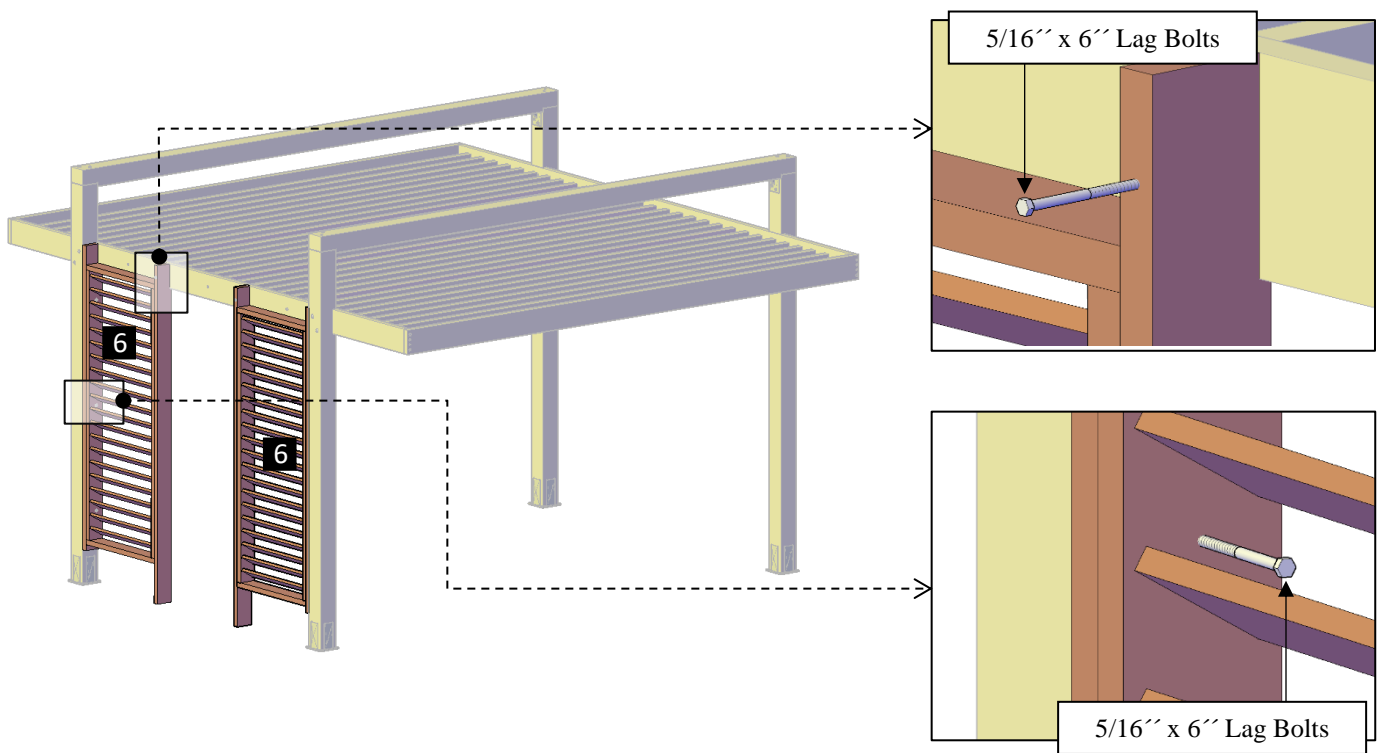

Step 9: Finally, use 3'' deck screws (**J**) to attach the boots (**7**) to the post. Each part has a series of numbers that indicate where to attach the part with the corresponding number.

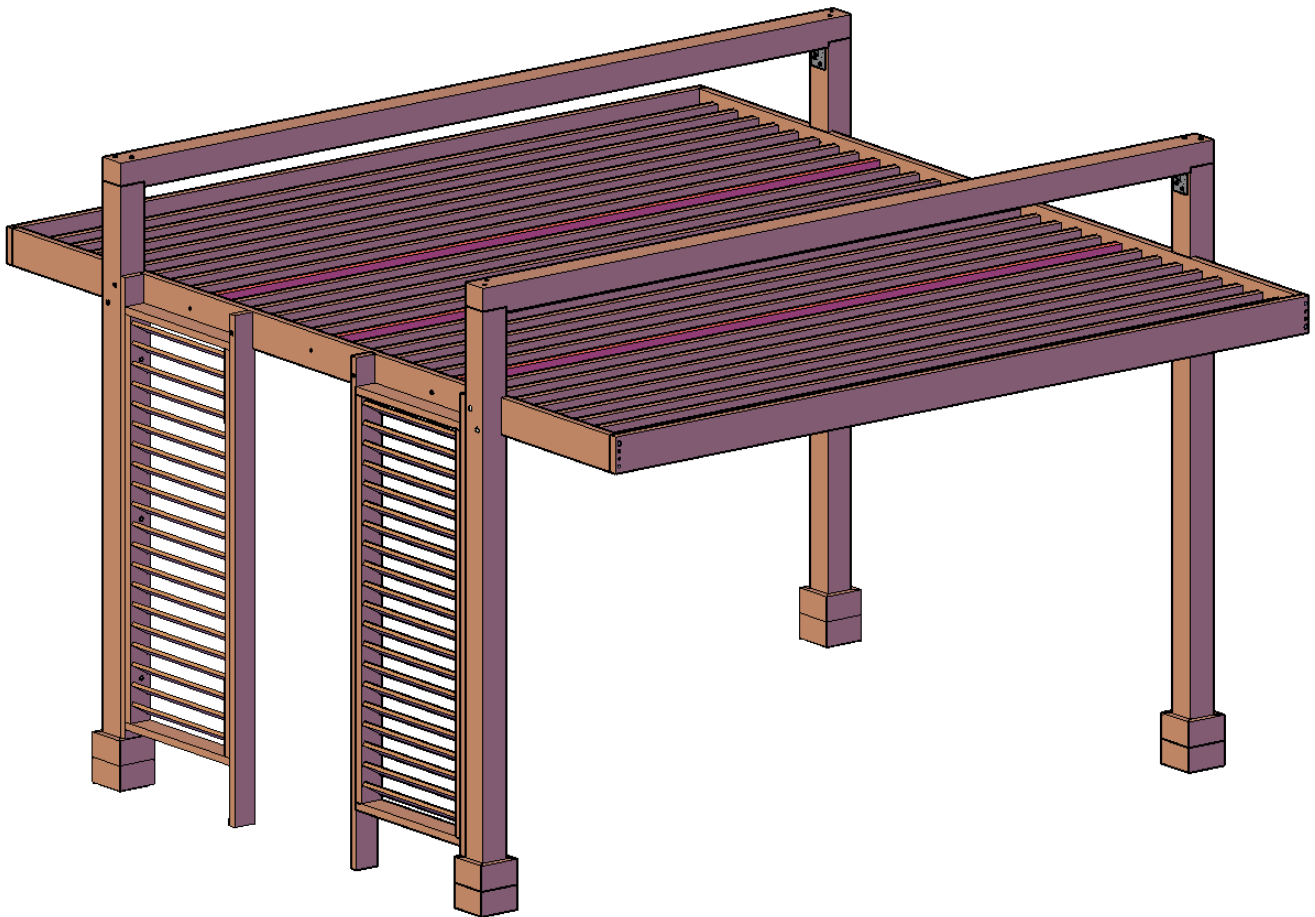
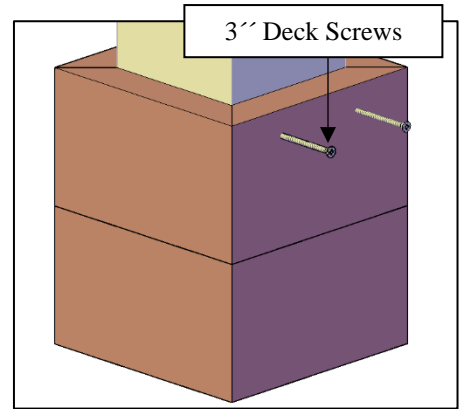
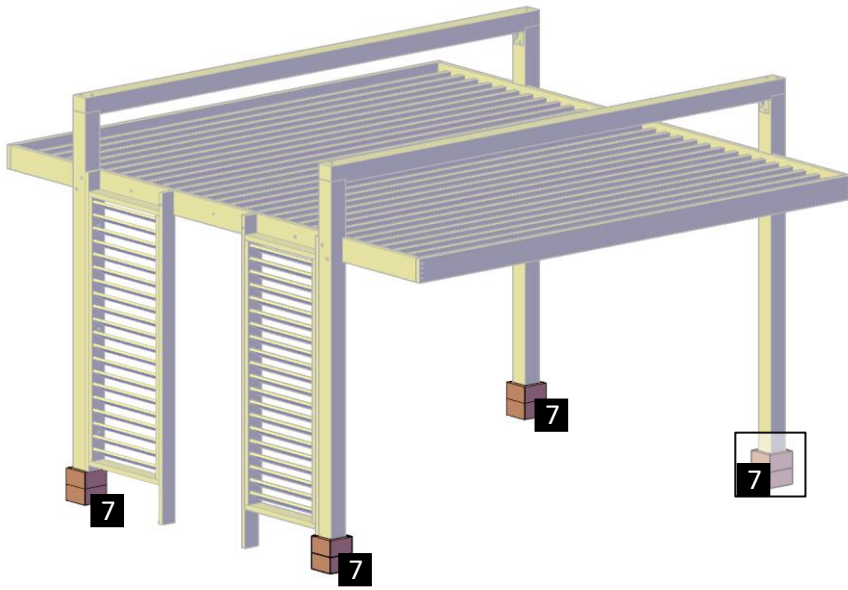



This completes the Pergola assembly. Hope you enjoy your set for many decades. If you ever have a problem or a question, don't hesitate to call us (866 332 2403) or email us. We are here to support you.